

Made for  
 iPod  iPhone  iPad

---

***Instruction Manual***

AT2020USBi  
Cardioid Condenser USB Microphone

***Contents***

Introduction & features	3
Setting up your microphone with pivot mount & desk stand	4
Preliminary setup with Mac OS X	5
Preliminary setup with Windows 8	6
Selecting software	9
Setting your software levels	9
Positioning your microphone	9
Protecting your microphone	9
Specifications	10

**Compliance with FCC rules (USA only)**

This device complies with Part 15 of the FCC rules. Operation is subject to the following two conditions:(1) this device may not cause harmful interference, and (2) this device must accept any interference received, including interference that may cause undesired operation.

**FCC WARNING**

You are cautioned that any changes or modifications not expressly approved in this manual could void your authority to operate this equipment.

**Canada only**

This Class B digital apparatus complies with Canadian ICES-003.

Cet appareil numérique de la classe B est conforme á la norme NMB -003 du Canada.

**Federal Communications Commission Statement**

**Note:** This equipment has been tested and found to comply with the limits for a Class B digital device, pursuant to part 15 of the FCC Rules. These limits are designed to provide reasonable protection against harmful interference in a residential installation. This equipment generates, uses and can radiate radio frequency energy and, if not installed and used in accordance with the instructions, may cause harmful interference to radio communications. However, there is no guarantee that interference will not occur in a particular installation. If this equipment does cause harmful interference to radio or television reception, which can be determined by turning the equipment off and on, the user is encouraged to try to correct the interference by one or more of the following measures:

- Reorient or relocate the receiving antenna.
- Increase the separation between the equipment and receiver.
- Connect the equipment into an outlet on a circuit different from that to which the receiver is connected.
- Consult the dealer or an experienced radio/TV technician for help.

Thank you for buying the Audio-Technica AT2020USBi Cardioid Condenser USB Microphone. Equipped with a digital output, this microphone is designed for digitally capturing music or any acoustic audio source using your favorite recording software. The AT2020USBi offers studio-quality articulation and intelligibility perfect for home studio recording, field recording, podcasting, and voiceover use.

The AT2020USBi features a microphone gain control that allows you to adjust the input level directly on the microphone itself. The microphone's cardioid pickup pattern delivers excellent off-axis rejection, while its A/D converter with a 24-bit, up to 96 kHz sampling rate ensures extremely articulate sound reproduction.

Audio-Technica's state-of-the-art design and manufacturing techniques ensure that the microphone complies with the company's renowned consistency and reliability standards.

### Features

- Condenser microphone with digital output for convenient recording
- High quality A/D converter with 24-bit, up to 96 kHz sampling rate for superb audio
- Mic gain control allows you to adjust input level on the mic itself
- Smooth, extended frequency response ideally suited for podcasting, home studio recording, field recording and voiceover use
- Compatible with Windows 7 and above, Mac OS 10.6 and above and iOS 7.02 and above (requires Lightning connector)
- Tripod desk stand with folding legs for secure and easily portable tabletop use
- Included USB and Lightning cables provide ready connectivity to computers and iOS devices

## AT2020USBi

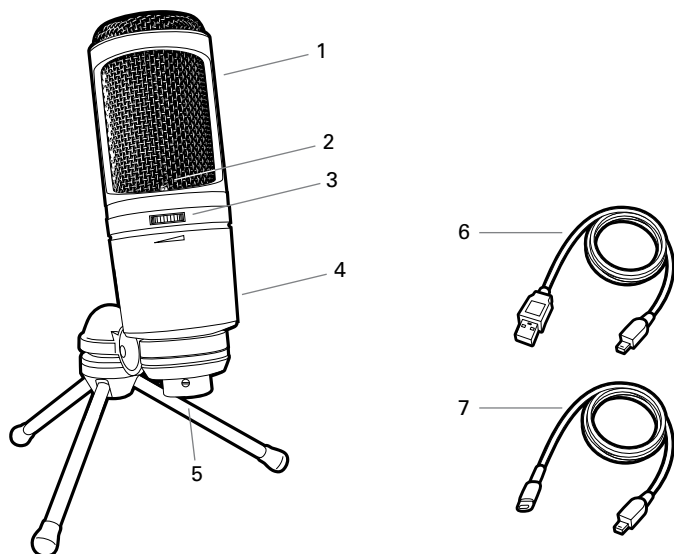

1. **Capsule** — Condenser microphone element with cardioid polar pattern
2. **Blue LED** — Blue light shows microphone is receiving USB power
3. **Mic Gain Control** — Dial controls input level
4. **Metal Construction** — Tough, durable, resilient design
5. **Digital Output Connector** — Use the included USB or Lightning cable to connect AT2020USBi to your Mac, PC, iPad or iPhone
6. **USB Cable**
7. **Lightning Cable**

### Setting up your microphone with included pivot mount and tripod desk stand

- A. Screw the pivot mount onto the top of the tripod desk stand.
- B. Place the tripod desk stand on a flat surface. (The tripod legs will extend to provide a wide, secure base.)
- C. Install the AT2020USBi microphone into the threaded collar of the pivot mount and tighten collar while holding the microphone in place. The front of the microphone should be facing the sound source. (A blue LED indicate the front of the microphone; the product model number is displayed on the rear of the microphone.)
- D. If necessary, adjust the microphone's angle with the pivot mount's thumbscrew.
- E. Plug the provided USB or Lightning cable into the digital output at the base of the microphone.

**Note:** Many recording software programs are available online. Audacity is widely used free software for recording and editing sounds. It is available online at <http://audacity.sourceforge.net/>

## Preliminary setup with Mac OS X

1. Plug the free end of the provided USB cable into the USB port on your computer. The microphone's blue LED will illuminate, indicating the microphone is receiving power. Your computer will automatically recognize the USB device and install a driver.
2. To select the AT2020USBi as your audio input, first, open your **System Preferences**.

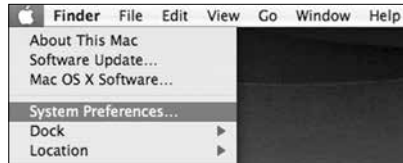

3. Next, click Sound to display the **Sound** preference pane.



4. Click the **Input** tab and select the **AT2020USBi** as the device for sound input.

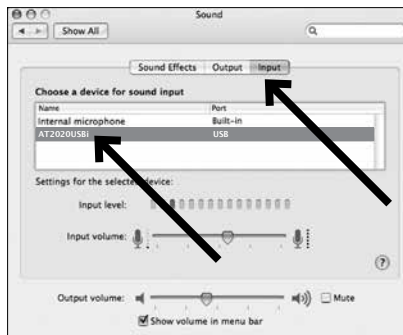

Your preferences are now set to use the AT2020USBi on your Mac with GarageBand or another recording program of your choice.

**Note:** Use the Lightning cable to connect the AT2020USBi to an iPhone or iPad. No setup is required.

---

## Preliminary setup with Windows 8

---

1. Plug the free end of the USB cable into the USB port on your computer. The microphone's blue LED light will illuminate, indicating the mic is receiving power. Your computer will automatically recognize the USB device and install a driver.
2. In the lower right portion of your screen you may get a message that new hardware was found; or you may see a driver software installation notice.
3. **Start menu > Control Panel > Sound**  
To select the AT2020USBi as your default recording device, begin at your Start menu. Select **Control Panel**.

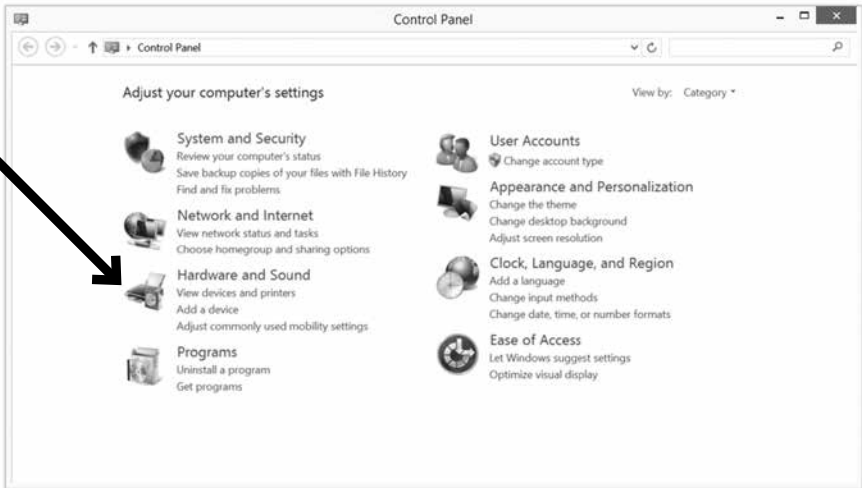

## Preliminary setup with Windows 8 (continued)

### 4. Select Sound.

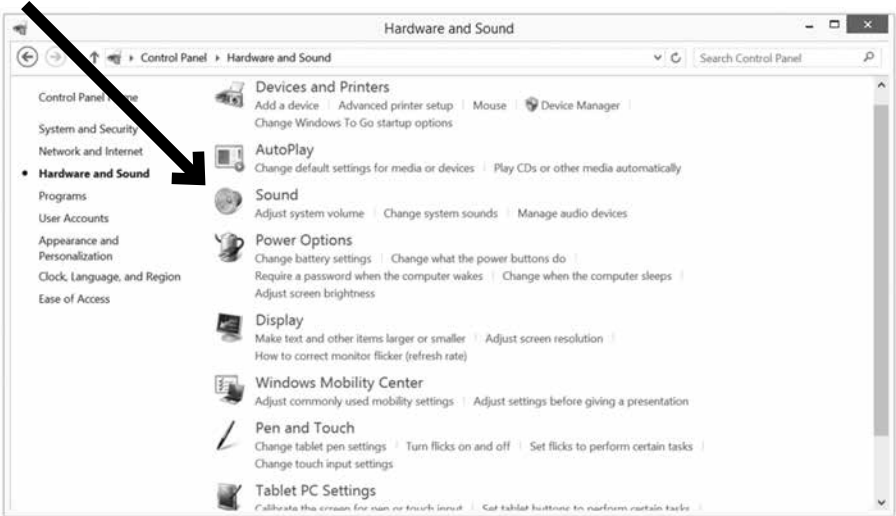

### 5. The following screen will pop up:



## Preliminary setup with Windows 8 (continued)

6. Select the **Recording** tab, and choose **AT2020USBi** as the default device.



7. Double click on the AT2020USBi icon to open the **Microphone Properties** window. Select the **Levels** tab to adjust microphone level (loudness). It is recommended that you set the gain control on the microphone to max before adjusting the level in Properties. That way any adjustments needed during recording can be easily performed from the microphone itself.



Your preferences are now set to use the AT2020USBi with Windows 8 and the recording program of your choice.



### **Selecting software**

You have many choices in recording software. Audacity, available for free online at <http://audacity.sourceforge.net/>, is a widely used software program that provides basic recording software.

### **Setting your software levels**

Correct adjustment of microphone level is important for optimum performance. Ideally, the microphone level should be as high as possible without overloading the input of your computer. If you hear distortion, or if your recording program shows levels that are consistently overloaded (at peak levels), turn the microphone volume (or level) down, through either the gain control on the microphone, your control panel (or system preferences) settings or your recording software. If your recording program shows insufficient level, you can increase the microphone gain via the microphone dial, the control panel (or system preferences) settings or your recording program.

No further microphone level adjustments should be needed, as long as the acoustic input does not change significantly.

### **Positioning your microphone**

It is important to position the microphone directly in line (on axis) with the person speaking/singing, the instrument (or other sound source) to achieve the best frequency response of the microphone.

For use in speaking/singing applications, the ideal placement for the microphone is directly in front of the person speaking/singing. The same placement is optimal when miking an instrument such as an acoustic guitar, drums or piano. Experiment with different mic placements to find the best sound for your particular setup.

### **Protecting your microphone**

Avoid leaving your microphone in the open sun or in areas where temperatures exceed 110° F (43° C) for extended periods. Extremely high humidity should also be avoided.

# AT2020USBi Specifications†

**Element:** Fixed-charge back plate, permanently polarized condenser

**Polar Pattern:** Cardioid

**Frequency Response:** 20 – 20,000 Hz

**Power Requirements:** USB (5V DC); Lightning (3.3V DC)

**Bit Depth:** 24-bit

**Sample Rate:** Up to 96 kHz

**Controls:** Mic gain control

**Weight:** 350 g (12.3 oz)

**Dimensions:** 162.0 mm (6.38") long, 52.0 mm (2.05") maximum body diameter

**Output Connector:** Micro HDMI

**Accessories Included:** Pivoting stand mount for  $\frac{5}{8}$ "-27 threaded stands;  $\frac{5}{8}$ "-27 to  $\frac{3}{8}$ "-16 threaded adapter; soft protective pouch; tripod desk stand; 4.9' (1.5 m) USB cable; 4.9' (1.5 m) Lightning cable

## Compatibility:

**Mac OS X v10.6 Snow Leopard and above**

USB1.0 or 2.0

Mac computer with an Intel processor

1GB of memory

5GB of available disk space

## Windows 7 and above

USB1.0 or 2.0

1 gigahertz (GHz) or faster 32-bit (x86) or 64-bit (x64) processor

1 gigabyte (GB) RAM (32-bit) or 2 GB RAM (64-bit)

The Lightning connector works with iPhone 6 Plus, iPhone 6, iPhone 5s, iPhone 5c, iPhone 5, iPad Air 2, iPad Air, iPad (4th generation), iPad mini 3, iPad mini 2, iPad mini and iPod touch (5th generation).

†In the interest of standards development, A.T.U.S. offers full details on its test methods to other industry professionals on request. Specifications are subject to change without notice.

## Frequency Response

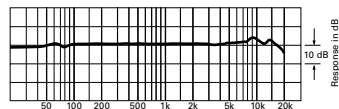

LEGEND — 12" or more on axis

## Polar Pattern

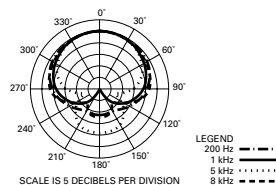

To reduce the environmental impact of a multi-language printed document, product information is available online at [www.audio-technica.com](http://www.audio-technica.com) in a selection of languages.

Afin de réduire l'impact sur l'environnement de l'impression de plusieurs, les informations concernant les produits sont disponibles sur le site [www.audio-technica.com](http://www.audio-technica.com) dans une large sélection de langue.

Para reducir el impacto al medioambiente, y reducir la producción de documentos en varios leguajes, información de nuestros productos están disponibles en nuestra página del Internet: [www.audio-technica.com](http://www.audio-technica.com).

To reduce the environmental impact of a multi-language printed document, product information is available online at [www.audio-technica.com](http://www.audio-technica.com) in a selection of languages.

Afin de réduire l'impact sur l'environnement de l'impression de plusieurs langues, les informations concernant les produits sont disponibles sur le site [www.audio-technica.com](http://www.audio-technica.com) dans une large sélection de langue.

Para reducir el impacto al medioambiente, y reducir la producción de documentos en varios leguajes, información de nuestros productos están disponibles en nuestra página del Internet: [www.audio-technica.com](http://www.audio-technica.com).

Para reduzir o impacto ecológico de um documento impresso de várias línguas, a Audio-Technica providência as informações dos seus produtos em diversas línguas na [www.audio-technica.com](http://www.audio-technica.com).

Per evitare l'impatto ambientale che la stampa di questo documento determinerebbe, le informazioni sui prodotti sono disponibili online in diverse lingue sul sito [www.audio-technica.com](http://www.audio-technica.com).

Der Umwelt zuliebe finden Sie die Produktinformationen in deutscher Sprache und weiteren Sprachen auf unserer Homepage: [www.audio-technica.com](http://www.audio-technica.com).

Om de gevolgen van een gedrukte meertalige handleiding op het milieu te verkleinen, is productinformatie in verschillende talen "on-line" beschikbaar op: [www.audio-technica.com](http://www.audio-technica.com).

本公司基於環保理由將減少多語言文件印刷，陸續產品訊息可在 [www.audio-technica.com](http://www.audio-technica.com) 的官方網頁上選擇語言與瀏覽。

本公司基于环保理由将减少多语言文件印刷，陆续产品信息可在 [www.audio-technica.com](http://www.audio-technica.com) 的官方网站上选择语言与浏览。

자원절약, 환경보호를 위해 국문 사용 설명서는 인쇄하지 않았습니다.

제품정보는 [www.audio-technica.com](http://www.audio-technica.com) 에서 원하는 언어 선택 후에 다운로드 받으실 수 있습니다.

"Made for iPod," "Made for iPhone," and "Made for iPad" mean that an electronic accessory has been designed to connect specifically to iPod, iPhone, or iPad, respectively, and has been certified by the developer to meet Apple performance standards. Apple is not responsible for the operation of this device or its compliance with safety and regulatory standards. Please note that the use of this accessory with iPod, iPhone, or iPad may affect wireless performance.

iPad, iPhone, iPod touch, and Retina are trademarks of Apple Inc., registered in the U.S. and other countries. iPad Air, iPad mini, and Lightning are trademarks of Apple Inc. The trademark "iPhone" is used with a license from Aiphone K.K.

---

# AT2020USBi

---



audio-technica®  
Audio-Technica Corporation  
audio-technica.com ©2015 Audio-Technica

